



NEW!

PLATO[®]

ROBOTIC SOLDERING TIPS

Plato, the leading manufacturer of replacement soldering tips for over 50 years, now offers top quality tips for robotic soldering stations. Because of our expertise in plating technology and soldering tip engineering, Plato tips improve soldering performance with split-second heat recovery.

Plato robotic tips feature long tip life, resisting the abuse of constant, repetitive robotic soldering without sacrificing soldering efficiency.

- Increased soldering speed by reducing heat recovery time
- Plating engineered for long tip life
- Custom tip development at reasonable minimums
- 50 years' experience in tip engineering



800-858-4043 | www.platoproducts.com

NEW!

PLATO

JAPAN UNIX COMPATIBLE SOLDERING TIPS

- Plating engineered for long tip life
- 1-piece design for faster heat throughput
- Custom tip development at reasonable minimums

DIMENSIONS ARE IN MM

COLOR AREA TINNED

00 - 0112

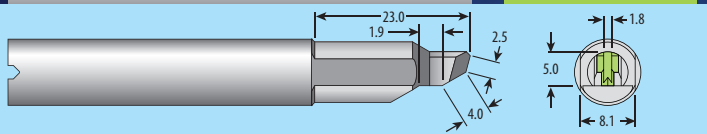

00 - 0118

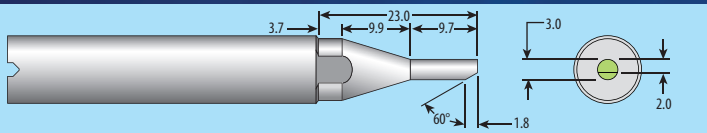

00 - 0120

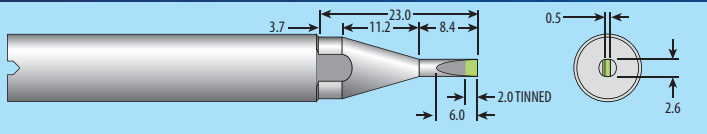

00 - 0121

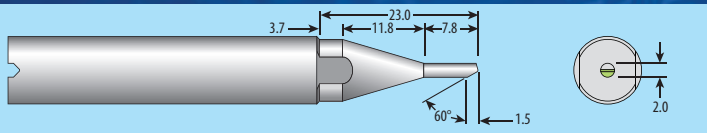

00 - 0181

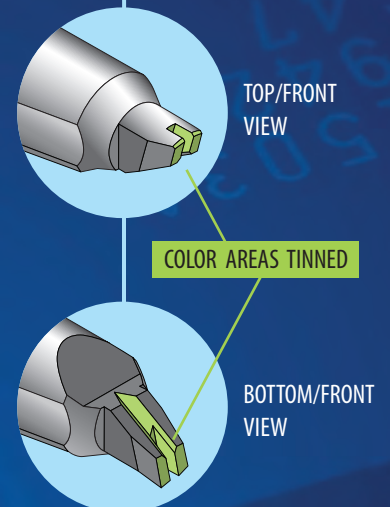
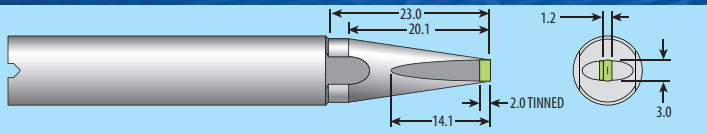

PLATO Custom Tip Engineering

Plato has a full-service engineering lab to custom design unique tip geometries to fit exact application requirements. Slight changes to current designs can increase production throughput, improve repeatability, minimize thermal stress, and reduce misaligned solder joints.

Plato utilizes computer-controlled machining equipment, so tooling cost is minimized. Minimum production runs can be as low as 100, at a significant cost savings compared to OEM tips.

Far from producing "knock-off" tips, Plato is the global go-to manufacturer of soldering tips throughout the industry. Plato is widely known for fast heat throughput and long tip life.

Plato engineers can take you through the design process in as short as 6-weeks:

- Assess customer requirements / specifications
- Initial design & PDF drawing approval
- Prototype approval
- Full production run

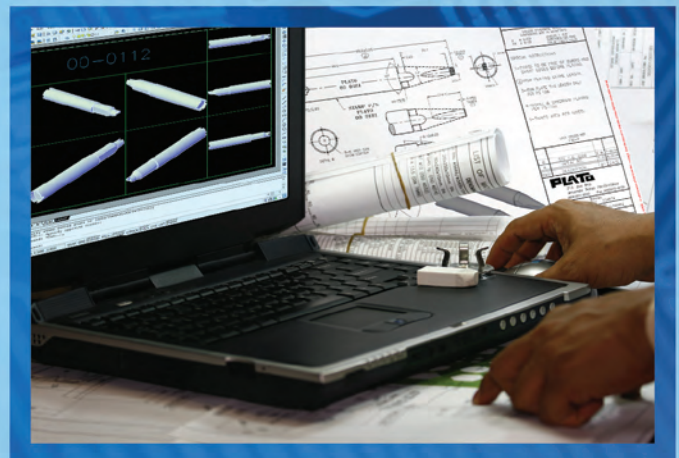

Contact your Plato representative and let's work together to increase your soldering throughput, improve quality, and reduce operating cost. . .

PLATO

8125 Cobb Center Drive, Kennesaw, GA 30152 USA | 800-858-4043
www.platoproducts.com | info@platoproducts.com